

# AVS50

## Product Data Sheet



### General Description

The AVS50 is a medium format louvre system specifically designed for commercial projects where increased airflow and/or free area performances may be required.

### Technical Details

#### Materials

- Manufactured With Extruded Aluminium Alloy to 6063 T6 (UK Sourced)
- Mechanically Jointed Corners
- Profile Thickness 1.5 mm

#### Performance

- Refer to BSRIA performance evaluation data on pages 2-5
- Independently Tested to BS 6180:2011 - Refer to Performance data on pages 6 and 7
- 50% Free area based on louvre core (excludes top and bottom blade arrangements and any intervening blade carrying profiles)
- Airflow performance Mean Ce 0.272 with Flyscreen / Ce0.257 with Birdguard

#### Dimensions

- 50 mm Blade Pitch
- 60 mm Depth o/all
- Glazing Rebate Height 30 mm

#### Options

- 24, 28 and 32 mm Glazed-In Outer Frames
- Box Frame and Flanged Outer Frame
- Hybrid Options
- Flyscreen (Stainless Steel or External Grade Black Fibreglass) or Birdguard
- Water Drainage Profile
- Enhanced Security Option
- Blanking Panels (Thermal or Standard)

# AVS50

## Performance Data 1

Classification from design tests undertaken by BSRIA on 12.08.2013 based on a 980 x 967 core louvre area (0.948 m<sup>2</sup>).

Weathering Performance with Flyscreen:

Ventilation Rate		Water Flow Rates		Effectiveness (%)	Classification
Volume (m <sup>3</sup> /s)	Velocity (m/s)	Supply (l/h)	Penetrated (l/h)		
0.00	0.00	93.0	1.0	98.6	B
0.47	0.50	93.0	1.3	98.2	B
0.95	1.00	93.0	6.1	91.4	C
1.43	1.51	93.0	11.6	83.7	C
1.89	2.00	93.0	20.3	71.5	D
2.37	2.50	93.0	32.5	54.3	D

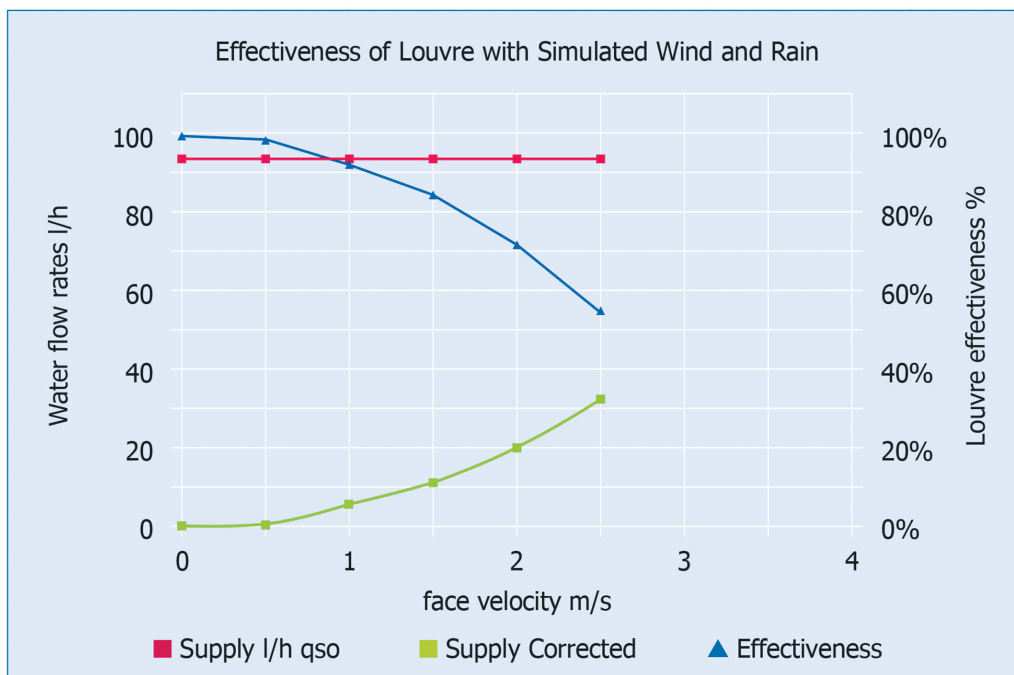

Weathering performance data includes water drainage profile. Please consult AVS for performance excluding drainage profile.

# AVS50

## Performance Data 2

Airflow Performance with Flyscreen:

Louvre pd Pascals (Pa)	Louvre Face Velocity (m/s)	Air Flow Rate Test Airflow (m <sup>3</sup> /s)	Volume (m <sup>3</sup> /s)	Coefficient C <sub>e</sub>
31.4	1.91	1.814	6.828	0.266
41.2	2.23	2.113	7.821	0.270
55.7	2.60	2.468	9.094	0.271
67.3	2.88	2.730	9.996	0.273
79.2	3.13	2.968	10.844	0.274
90.9	3.32	3.148	11.617	0.271
102.7	3.54	3.356	12.348	0.272
117.6	3.82	3.620	13.213	0.274
130.4	4.01	3.804	13.914	0.273
150.7	4.30	4.076	14.958	0.273
mean C <sub>e</sub>				0.272
Class				3

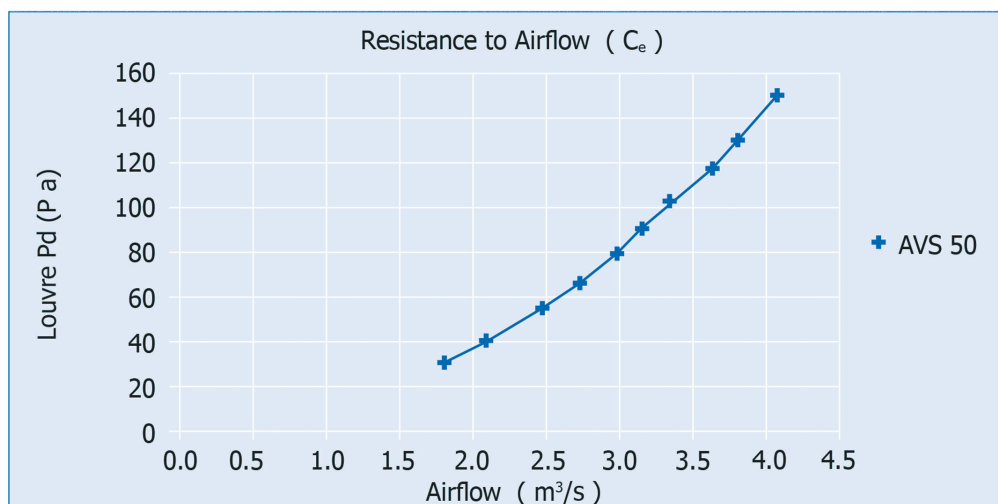

NB. The theoretical airflow rate is based on the face area of the louvre with the blades removed, and the coefficient is the measured airflow rate divided by the theoretical airflow rate.

# AVS50

## Performance Data 3

Weathering Performance with Birdguard:

Classification from design tests undertaken by BSRIA on 12.08.2013 based on a 980 x 967 core louvre area (0.948 m<sup>2</sup>).

Ventilation Rate		Air Flow Rate		Effectiveness (%)	Class
Volume (m <sup>3</sup> /s)	Velocity (m/s)	Supply (l/h)	Penetrated (l/h)		
0.00	0.00	93.0	5.0	92.9	C
0.47	0.50	93.0	6.9	90.2	C
0.95	1.00	93.0	8.2	88.5	C
1.42	1.50	93.0	12.7	82.2	C
1.89	2.00	93.0	19.9	72.0	D
2.37	2.50	93.0	36.6	48.4	D

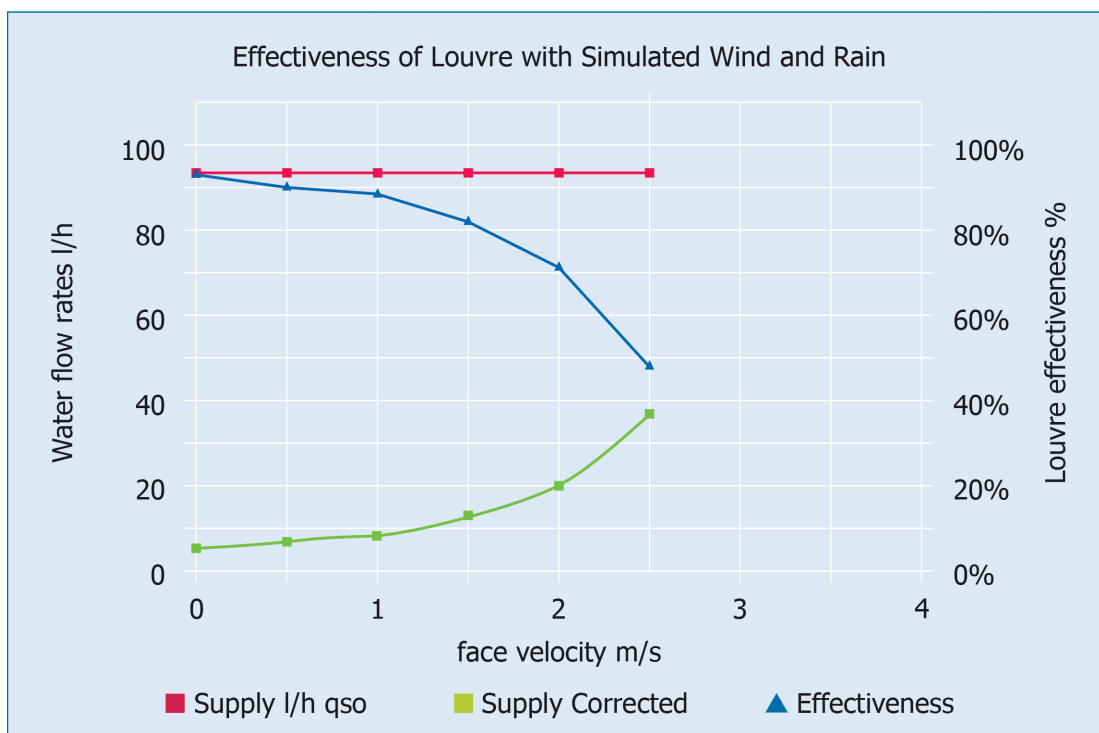

Weathering performance data includes water drainage profile. Please consult AVS for performance excluding drainage profile.

# AVS50

## Performance Data 4

Airflow Performance with Birdguard:

Louvre pd Pascals (Pa)	Louvre Face Velocity (m/s)	Air Flow Rate Test (m <sup>3</sup> /s)	Theoretical (m <sup>3</sup> /s)	Coefficient C <sub>e</sub>
33.1	1.90	1.816	7.060	0.257
45.6	2.23	2.130	8.287	0.257
61.4	2.59	2.474	9.616	0.257
74.7	2.86	2.724	10.606	0.257
87.8	3.09	2.945	11.499	0.256
100.2	3.31	3.160	12.284	0.257
112.4	3.52	3.360	13.010	0.258
132.3	3.81	3.634	14.115	0.257
144.4	4.00	3.811	14.746	0.258
163.9	4.23	4.032	15.710	0.257
mean C <sub>e</sub>				0.257
Class				3

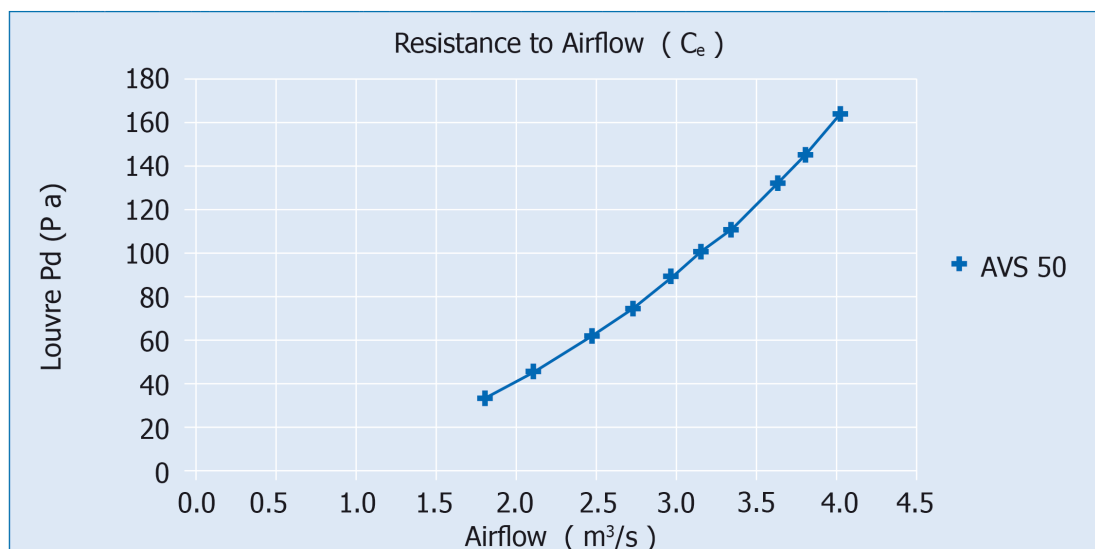

NB. The theoretical airflow rate is based on the face area of the louvre with the blades removed, and the coefficient is the measured airflow rate divided by the theoretical airflow rate.

# AVS50

## Performance Data 5

Testing of AVS50 SM Louvres to BS 6180:2011

AVS50 SM (Surface Mounted) Louvres have been subjected to a horizontal line load of 0.74 kN/m, Uniform Distributed Load of 1.0 kN/m and Point Load of 0.5 kN/m and comply with the permissible deflection requirements of the standard.

Results are as the table below:

### Test sample: 1000 mm width x 2000 mm high.

Louvre Type	0.74 kN/m Horizontal Line Load	1.0 kN/m <sup>2</sup> Uniformly Distributed Load	0.5 kN Point Load	BS 6180 Requirement ≤ 25.0 mm
	Maximum Deflection, mm			
AVS50M	2.46	2.06	4.22	Complies

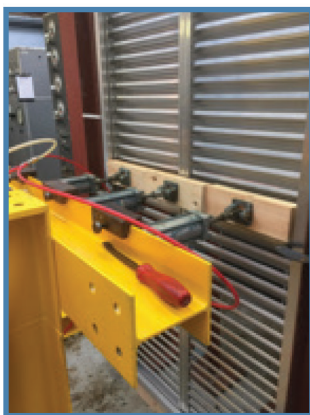

Horizontal Line Load  
(Internal view of test)



Point Load  
(Internal View of Test)

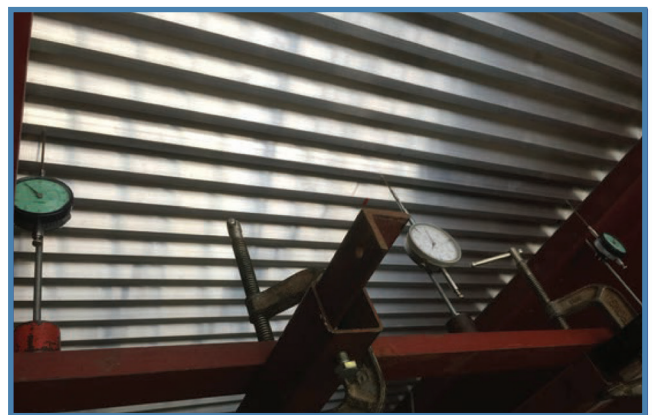

Internal View of Horizontal  
line load test

**Please note that if Louvres are required to meet the test standards above we must be notified at point of order and not retrospectively.**

Testing was undertaken by:  
BUILDING INVESTIGATION AND TESTING SERVICES (SURREY) LTD Quarryside Business Park, off Holmethorpe Industrial Estate, Thornton Side, Redhill, Surrey, UK, RH1 2LJ

Test Report Ref: GT8090/1/CDL/16  
A full copy of the test report is available upon request

# AVS50

## Performance Data 6

Testing of AVS50 SM Louvres to BS 6180:2011

The test was performed following the principles of BS 6180: 2011. The Standard states that the maximum allowable deflection of the barrier shall be 25 mm. In addition, following the principles of Section 6.5 of BS 6180 a separate load, increased by 50%, was applied for each of the three loads.

### Test sample: 1000 mm width x 2700 mm high.

Test 1	Load	Deflection	Pass/Fail
Line load	0.74 kN	6.101	Pass
Point load	0.5 kN	3.201	Pass
Uniform distribution load (UDL)	1.0 kN/m <sup>2</sup>	5.845	Pass

Test 2	Load	Result
Line load	1.11 kN	No damage observed
Point load	0.75 kN	No damage observed
Uniform distribution load (UDL)	1.5 kN/m <sup>2</sup>	No damage observed

Test 3	Load	Deflection	Pass/Fail
Line load	1.5 kN	6.836	Pass
Point load	1.5 kN	8.903	Pass
Uniform distribution load (UDL)	1.5 kN/m <sup>2</sup>	5.865	Pass

Test 4	Load	Result
Line load	2.25 kN	No damage observed
Point load	2.25 kN	No damage observed
Uniform distribution load (UDL)	1.5 kN/m <sup>2</sup>	No damage observed

**Please note that if Louvres are required to meet the test standards above we must be notified at point of order and not retrospectively.**

Testing was undertaken by:  
Build Check Ltd, Unit 5, Lincoln Park Business Centre Lincoln Road, High Wycombe, Bucks HP12 3RD

Test Report Ref: CW21484-1  
A full copy of the test report is available upon request

# AVS50

## Product Variants

### AVS50 GL 24

---

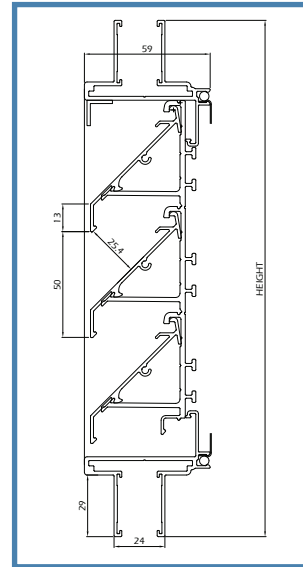
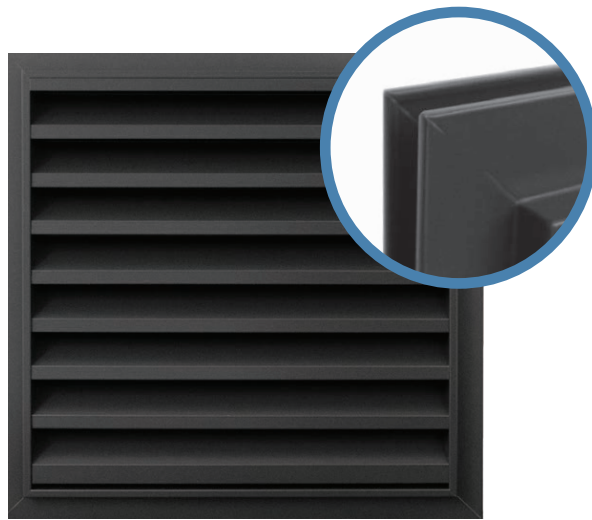

### AVS50 GL 28

---

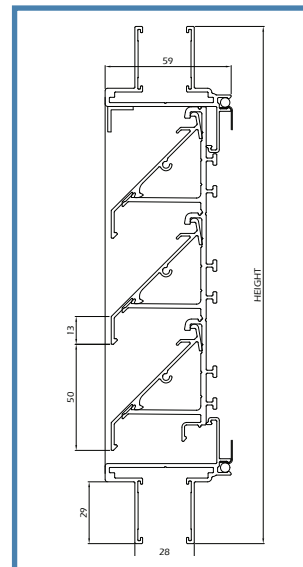
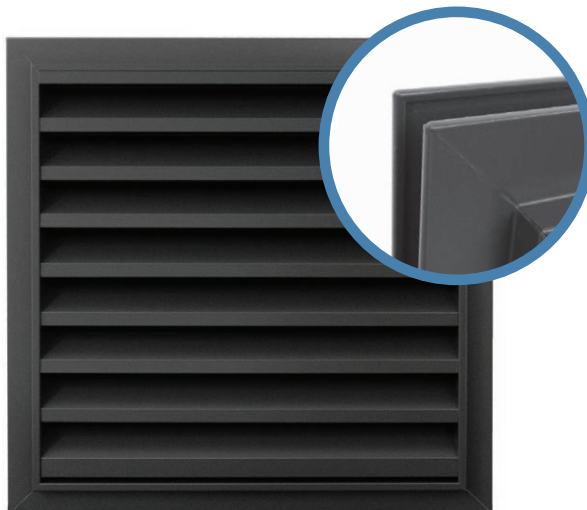

# AVS50

## Product Variants

### AVS50 GL 32

---

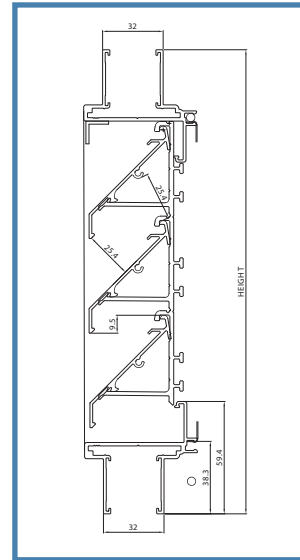
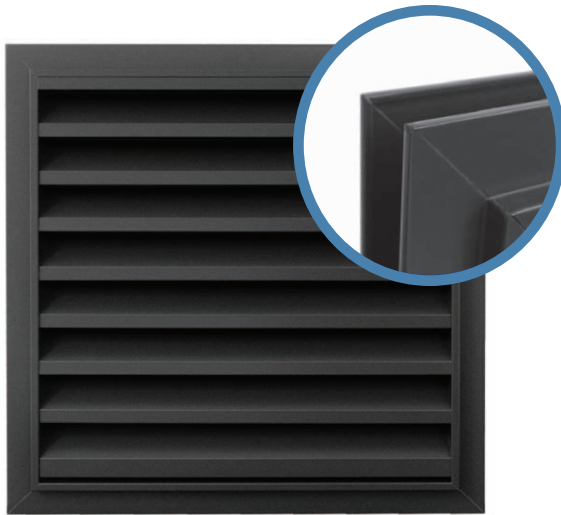

### AVS50 FL

---

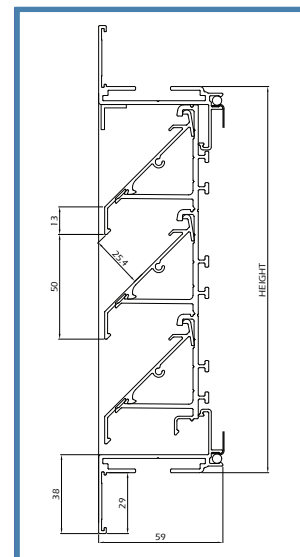

# AVS50

## Product Variants

### AVS50 EXFL

---

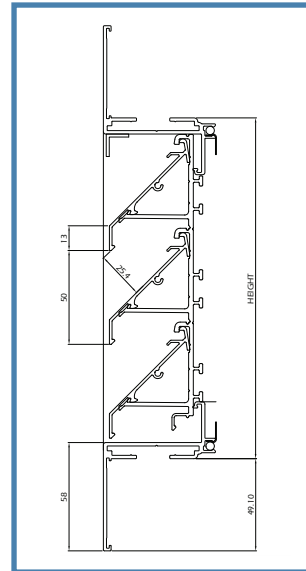

### AVS50 SM

---

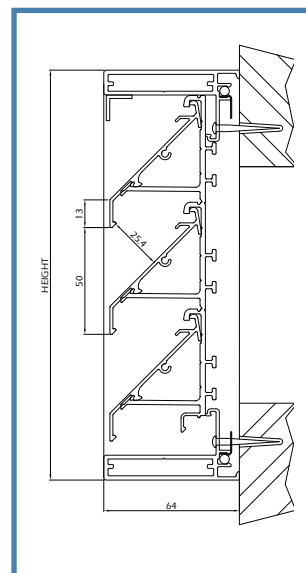
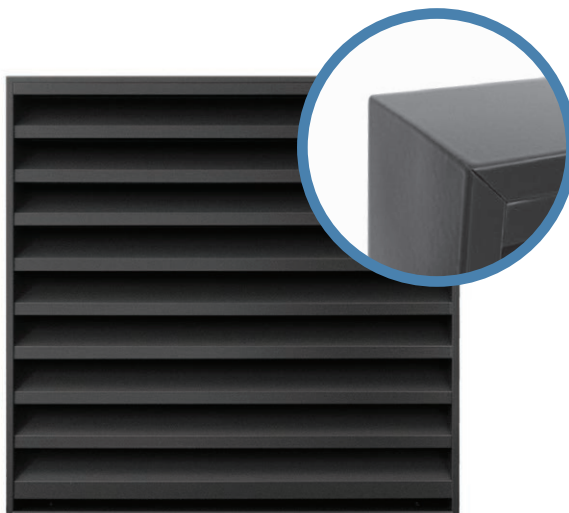

# AVS50

## Product Variants

### AVS50 BF

---

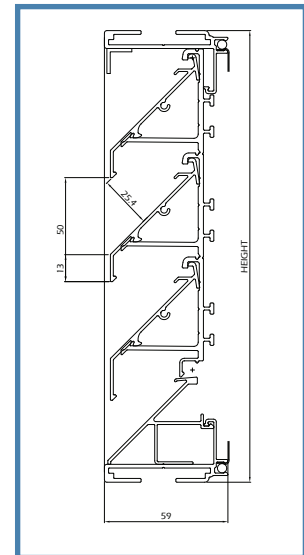
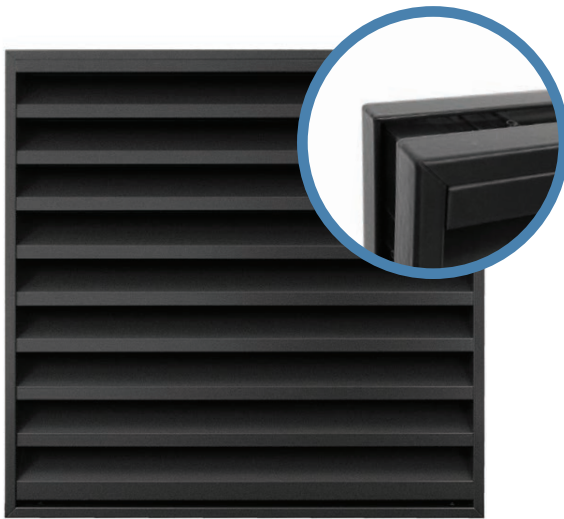

### AVS50 JOINED GLAZED-IN LOUVRES

---

